

# MULTIWIRE CUTTER NDF-6840/35

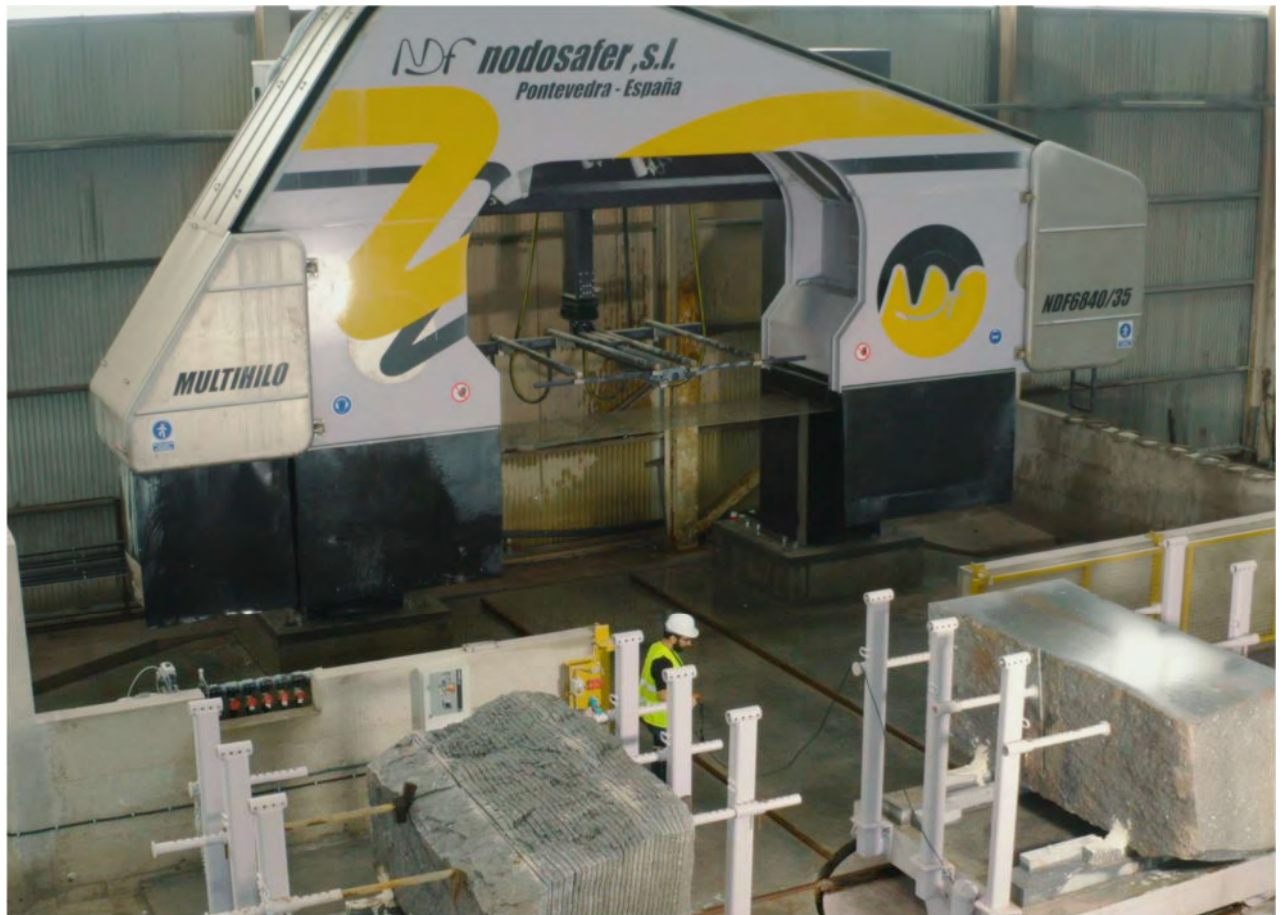

## 1- DESCRIPTION:

The new Diamond wire cutting machine NDF 6840/35, is a multi-wire machine designed to produce boards and plates of varying thickness from the large blocks of granite and natural stone. This new unit represents the most modern technology in what refers to the primary sawing of the stone blocks, becoming the alternative to the traditionally used sawing methods, since it improves the production capacity quantitatively, efficiently taking advantage of the energy resources needed to the production of materials and significantly reducing the production costs of the cutting phase.

The multiple diamond wire cutter is a machine that stands out for its efficiency and high productivity, designed to obtain high yields, which is characterized by its great robustness, thanks to its particular design that forms a compact, balanced and balanced set where all movements are concentrated, and its proven reliability and that of the elements that compose it, being all designed to withstand the toughest working conditions.

The main structure of the machine is basically composed of two sturdy columns formed by two steel-welded steel structures, connected between them by an upper crossbar. On both columns the structure of the main frame that joins the two trolley-carriages is mounted, which move vertically supported on both columns on linear guides with linear roller recirculation skates and actuated by a pair of spindles rolled with recirculating nuts balls, synchronized and operated by two motor-reducers with independent servo motors for the ascent / descent of the threads with a smooth and precise movement, located in the upper part of both columns, the entire guide assembly is perfectly protected by PVC bellows . The servomotors are synchronized by software in the vertical movements that ensure smooth cutting, low consumption, and maximum precision and avoid the slacks and problems of the central motorization with transmission and forwarding.

The Ø1800 drive drum is formed by a single multi-channel pulley with grooves and connected to the main motor by a pulley and timing belt transmission. The threads are manually positioned according to the desired thickness supported by one side of the machine on the drive drum, and in turn are tensioned from the opposite end by autonomous pulleys. The diamond wires are also guided by two

multichannel drums that help to significantly reduce the arrow produced by them. From the opposite end to the driving drum, the diamond wires are supported by the set of idle pulleys, designed with a particular pivoting extraction system, which allows reducing maintenance times significantly.

Once the wires are located, these are adjusted with the active tensioning device that acts individually on each of the tensioning pulleys, independently ensuring that each of the threads has the same tension regardless of the minimum differences in length between each of the threads that are installed in the machine. The tensioning system manages to increase the useful life of the wires and therefore the profitability of the machine.

The whole machine is characterized by the robustness and reliability of the elements that compose, being all designed to withstand the toughest working conditions, and in this aspect it is precisely where we can provide all the experience accumulated over the years we have been designing and manufacturing machinery for this sector.



The NDF 6840/35 Multiwire Cutter stands out for the following features:

- Reduced and optimized energy consumption.
- Mechanical robustness and absence of vibrations.
- Active and independent tensioning system, which increases the useful life of the threads, increasing profitability and ensuring optimum surface finishes.
- Innovative pulley design, with pivoting extraction system that reduces maintenance times.

- Full range of cutting thicknesses, thanks to its particular design of pulley packages and combination of grooves, without penalizing the life of the diamond wire.
- Excellent precision and flatness of cut, through its particular system of guidance by linear skates and its rigid bearing structure.
- Easy and convenient access to the inside of the machine, thus facilitating the work of changing threads and their maintenance.
- Helical spindles with large diameter balls in vertical movement for smooth or precise movement.
- Servomotors synchronized by software in vertical movements that ensure smooth cutting, low power consumption, maximum precision and avoid gaps and problems of central motorization with transmission and forwarding.
- Up to 35 wires with various possibilities for the combination of cutting thicknesses.



## 2 -STRONG POINTS:

The multiple diamond wire cutter is a multi-wire cutter designed to produce slabs, boards and slabs of varying thickness from the large blocks of granite and natural stone. Traditionally in the factories of transformation of the granite, the sawing of the blocks is being made of the size of the same with looms when the blocks are of big dimensions, or with bridge cutters of big diamond discs in the workshops of stonework when cut semi-blocks.

*The biggest aspect to note is that the multi-wire cutter, for an equivalent capacity, the effective energy consumption, is lower compared to any of the methods used. This translates into significant energy savings both in the implementation, as in production costs.*

This difference in the equivalent energy saving is mainly due to the difference in sawing technology, the multi-wire cutter only uses up to 35 loops of diamond wire and water during this process by cutting continuously. These diamond wires are basically formed by a steel cable covered by diamond rings along the cable, the cutting effect on the stone block to obtain the slabs and boards is produced by the effect of the continuous drag movement of the wires at a linear speed of about 30 meters / sg. combined with the rotation of the rings, producing a very high cutting power, differentiated effect with respect to the large traditional looms where the cutting process can be defined as the effect of a reciprocating saw, formed by a frame that houses about 100-130 steel strips in contact with the stone blocks at the same time moving c in combination with the rain of abrasive mixture of water, steel shot and lime, which produces the same amount of incisions in the stone block that amount of strapping.

*In summary, the coefficient resulting from the equivalent energy consumption in Kw / m<sup>2</sup> of a multi-wire cutter compared to the loom is greater than 50% savings, even considering that the total installed power of a multi-wire cutter is greater than that of a traditional loom.*

The Multiple Diamond Wire Cutter is the alternative to the primary sawing methods currently used, improving the production capacity quantitatively, efficiently taking advantage of the energy resources necessary for the production of materials and significantly reducing waste produced during the cutting phase.

Comparatively, the advantages of using this new technology applied to the multi-wire cutter are obvious. The multi-wire cutter can cut any type of stone material in front of looms that only cut granites or marble, but these are two different models and that use different tools, the looms are only profitable when cutting 2-3 cm sheets of thickness, but its biggest disadvantage is in the energy consumption and the very high production of solid waste, since the water used is recovered in all cases, this waste apart from assuming a higher purification cost, presents a problem of environmental pollution in case of the looms because it contains iron, and the lime that alters the acidity of the waters, in addition to the moment it is not possible to separate or recover at this stage of the process. There is an important difference compared to traditional cutters, which is based on the cutting height, with a disc we can cut 1.50 meters in front of the diamond wire that any commercial block can cut, apart from the great productive difference that exists.

The water treatment and purification process for this new process is therefore more economical and less complex.

*It is also worth noting that the water needs, while being similar, with respect to the traditional loom, the diamond wire cutting practically cancels the need to wash the load after sawing, this being much less demanding and both the needs and Water losses during the cutting process are lower.*

Another aspect to note is that the multi-wire cutter, for an equivalent capacity, the effective energy consumption, is lower compared to any of the methods used. This translates into significant energy savings both in the implementation, as in production costs.

With respect to consumables, say that in the multi-thread cutter there is only one; the diamond wire, small volume, easy storage and simple supply. The costs derived from storage, stock programming and handling, are also lower with respect to strapping, shot and lime, necessary for the traditional loom.

In reference to the costs of implementation, the simplicity and the consequent lower cost of civil works stand out in the first place, while in the loom the necessary work constitutes an indispensable part of it, in the multi-wire cutter, this becomes a mere support of it. In addition, in the case of renewal or replacement of the machine, the loom forces the new implantation to be exactly the same model as the previous one, while in the case of the multi-threaded cutter there is a high degree of possibilities of being able to make an adaptation of the existing civil works. In any important case, that is, the space occupied by the multiwire is less.

The simplicity of the multiwire is significantly greater, both in installation, use and handling, as well as in maintenance, both mechanically and electrically. It is important to note that the NDF-6840/35 multi-wired cutter does not use the common solution for vertical movement consisting of a central motor with reducer, transmissions and angular forwarding. This is replaced by two independent and electronically synchronized servomotors without coupling between them. This solution, in effect, cancels the inconveniences of the classic mechanical transmissions, the clearances and possible breaks due to wear and fatigue, and also allows us greater flexibility in the movements to be carried out. In this regard, it should be noted that the system is capable of working at speeds as slow as one millimetre per minute, as at the fastest of almost one meter per minute, all without loss of power or precision in movement.

As a practical effect, the NDF-6840/35 cutter is the fastest machine on the market capable of performing a vertical ascent movement against any contingency, avoiding the undesirable marks of diamond wire in the stone.

*The surface of the final product serrated with the diamond wire, in addition to the fact that it does not need to be practically washed, much less the use of harmful acids or chemicals and dangerous handling, offers the important advantage that its surface state can be assimilated to a certain jaded. In the event that the material must be subsequently polished, a certain reduction in the costs associated with the abrasives used in the polishing process and the consequent reduction in production times should be noted.*

The high speed of the multiwire cutter will also allow new users of this technology to schedule production with a lower advance and greater flexibility than the loom, even allowing partially cutting a block and reserving the rest of it for another more appropriate time.

*The flexibility of production is also given by the clearly lower staffing needs. The preparation of the saw in a thread cutter for a cut, consumes less than half the time and less than half of human resources than a traditional strapping loom.*

With this cutting unit it is intended to integrate the fully automated operation of the primary sawing work of the stone blocks, with the minimum human intervention and therefore a significant reduction in the manoeuvres of product handling, regularization and optimization of the work processes, the increase of the productive capacity thanks to the reduction of the cycle times and the efficient use of the dead times, the reduction of the energy consumption and the production of the waste during the cutting process, and finally the reduction of the associated risks for the personnel involved in the work of manipulation and mechanization of the materials throughout each working day.





### 3 - WHY BUY OUR CUTTER:

The use of diamond wire in primary sawing work has been used in the sector for not many years, and this wire is applied on known machines, usually made up of two pulleys on which a wire is installed forming a closed loop with the that the cuts are made on the stone blocks.

In recent years, machines that use several diamond wires have begun to be used, which are mounted on multi-channel drums or made up of several pulleys, on which several threads are mounted in order to make several cuts at once on the stone blocks, thus obtaining significant productions.

The machines used up to now have different technical problems when making the correct tensioning and control of the wire loops, in addition to a more significant one that lies in the possibility of varying in a simple way the position of the pairs of wires with in order to obtain different thicknesses or vary them in the production of boards.

Taking these disadvantages into consideration, the cutter N.6840 / 35 stands out for its simplicity in the individual tensioning device of the tension wheels, and at the same time the variation of processing thicknesses in the slabs and boards to be cut has been simplified simple and easy.

Nodosafér offers its clients in addition to all the intrinsic characteristics of any thread machine, improvements as important as:

- **Architecture based on a robust and compensated structure to avoid vibrations.**
- **Maximum protection against the penetration of water and dust in the most sensitive parts.**
- **Helical spindles with large diameter balls in the vertical movement for smooth and precise movement.**
- **Linear guides of recirculation of rollers in the columns to guarantee the absolute verticality of the cut.**

- Servomotors synchronized by software in vertical movements that ensure smooth cutting, low power consumption, maximum precision and avoid gaps and problems of central motorization with transmission and forwarding.
- Basic mechanism of large diameter drive drum that prolongs the life of the wire.
- Automatic tensioning device by independent pulleys of each of the threads, with position, arrow and tension control of each of the threads.
- Automatic and progressive speed reduction in case of excessive arrow in the wire.
- Wire break detection and controlled stop (rapid braking and maximum speed rise)
- Controlled emergency stop to avoid markings on the cut block.
- Possibility to resume a cut automatically or semi-automatically.
- Wide range of devices and program functions for operator and machine safety.
- Motorized car with optional position control.
- Colour operator panel with ease of handling and multiple configuration possibilities.
- Compact electrical panel with the latest technologies.
- High power main motor driven by inverter.
- Button panel for movements in manual mode.
- Automatic greasing.

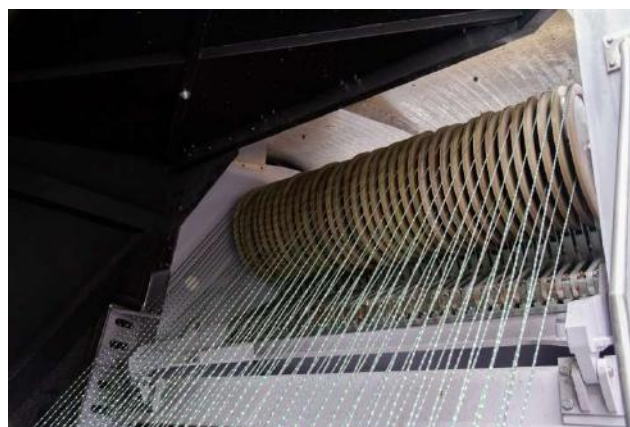

#### 4 CONSTRUCTION DETAILS:

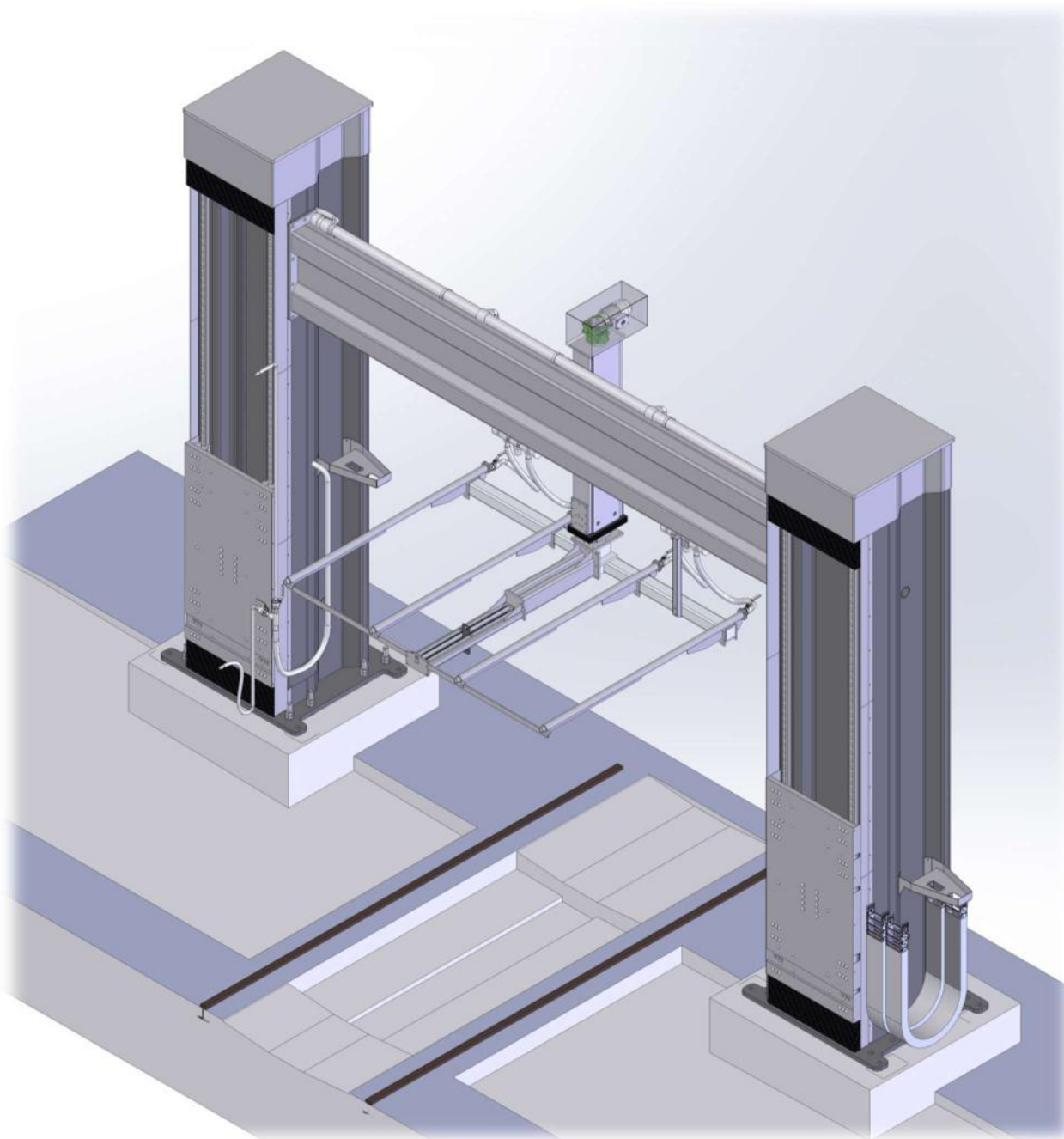

Fig. 1 – Detail columns with linear guides, crossbars and plate separator

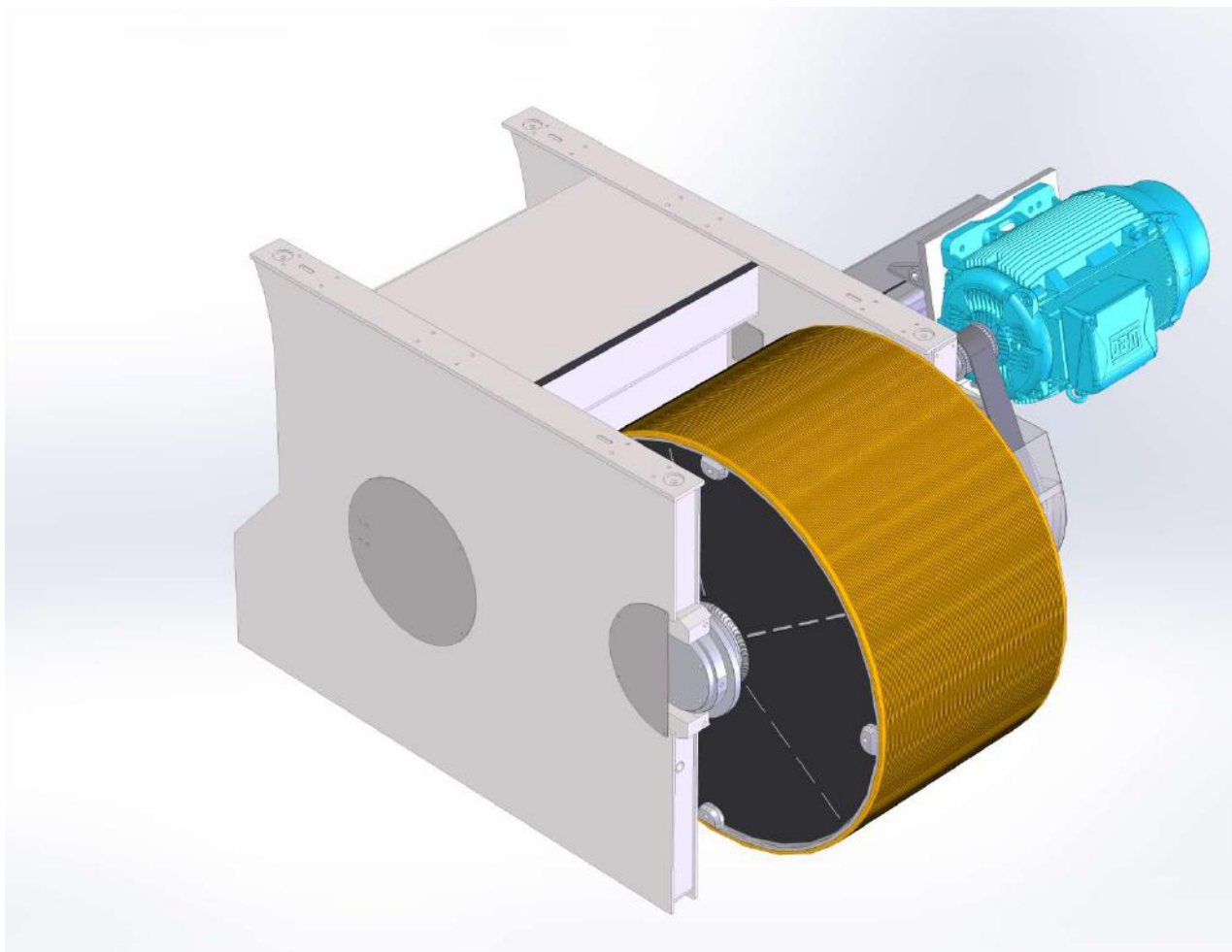

Fig. 2 - Detail of the drum unit, supports and engine transmission.

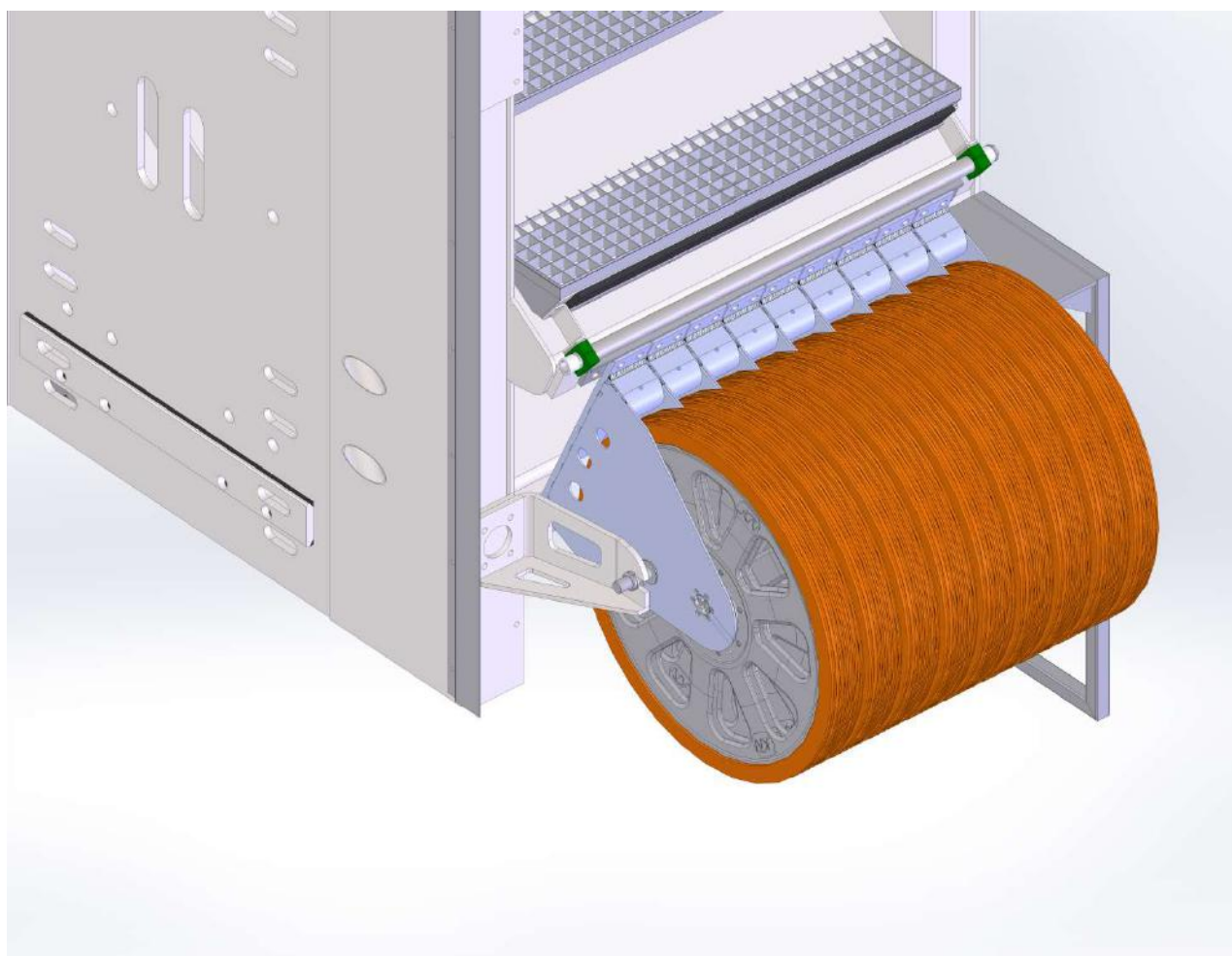

Fig.3 – Detail set of removable free pulleys with pivoting extraction system

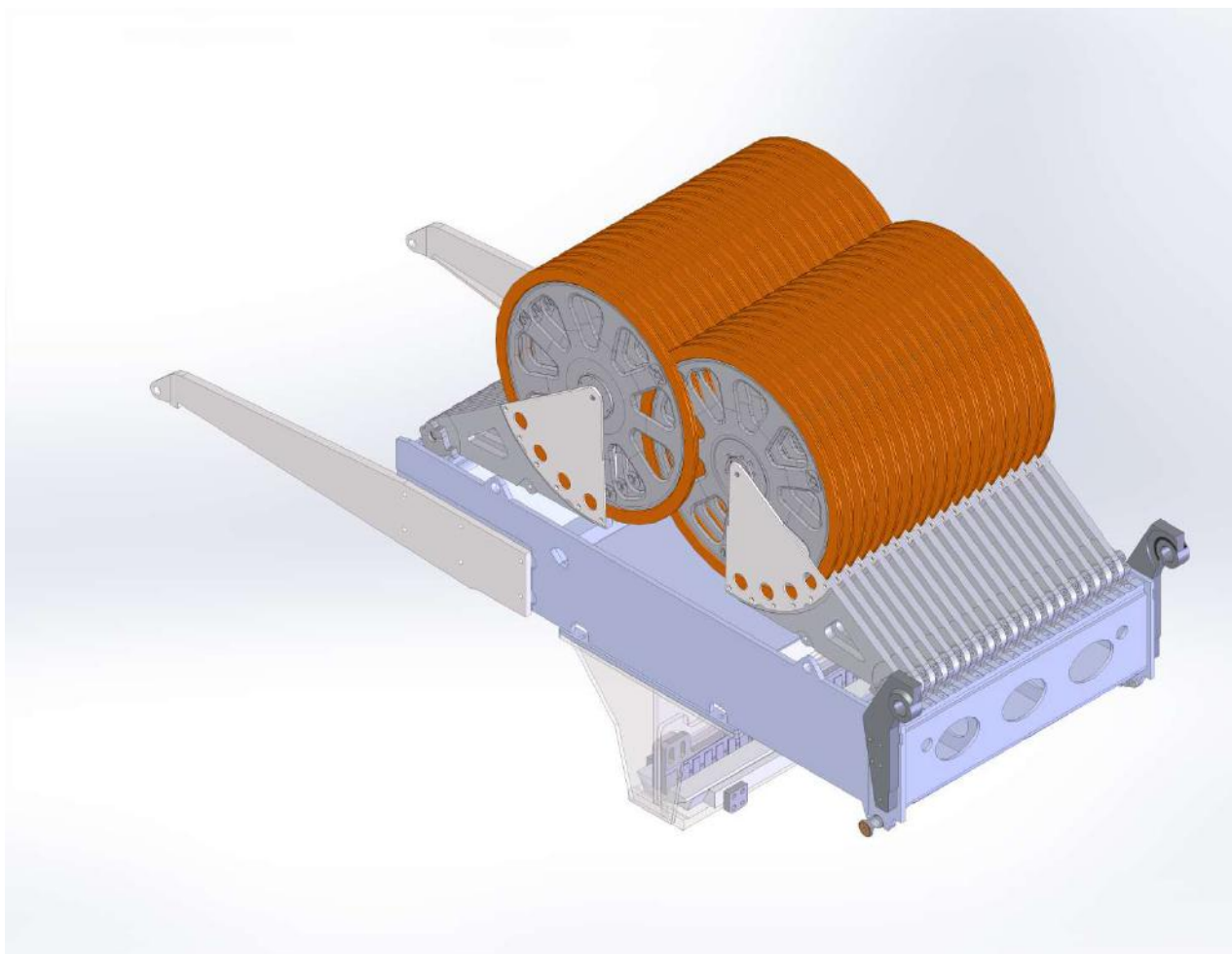

Fig.4 – Detail of the tension pulley assembly, on articulated arms with independent tension cylinders

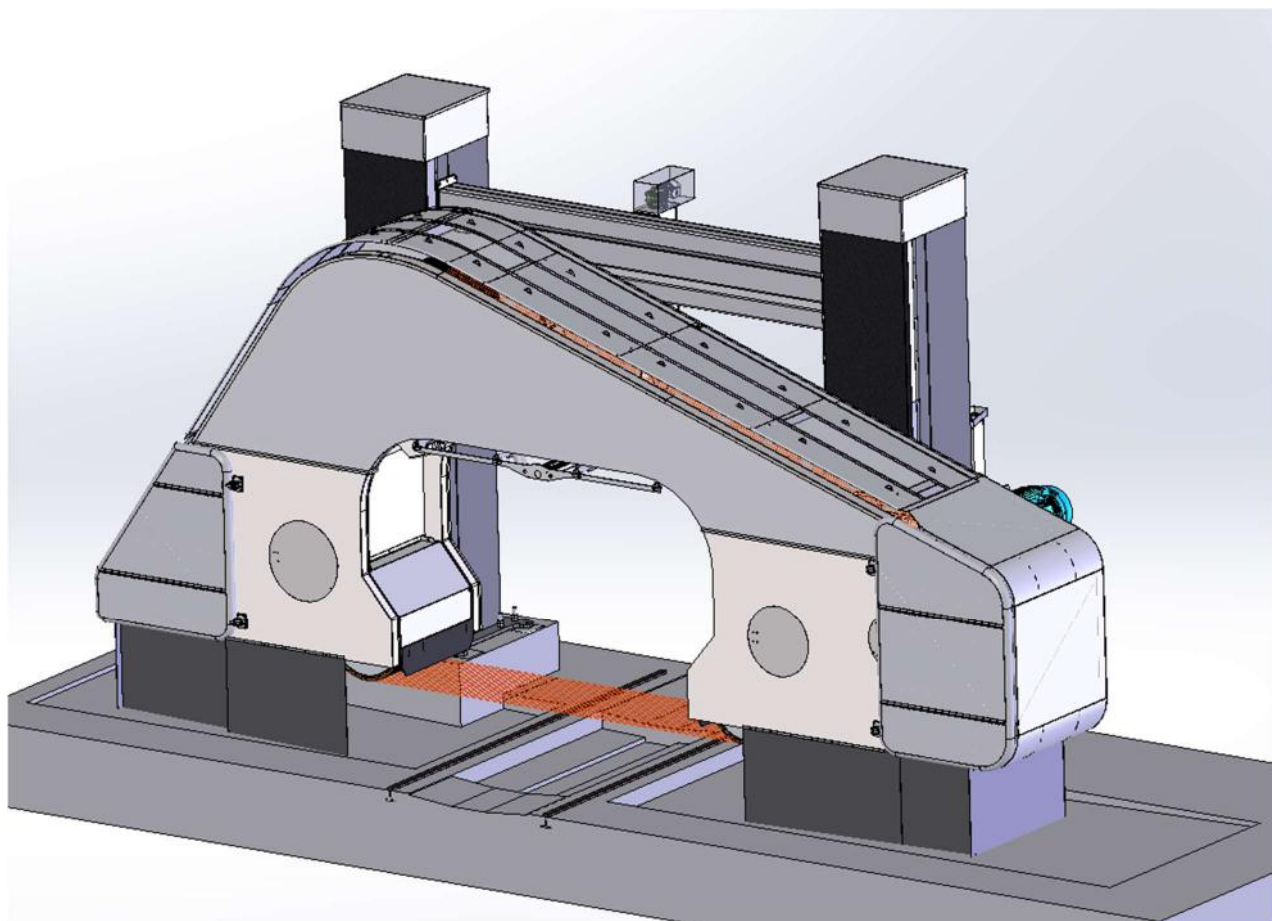

Fig. 5 - Detail of the main frame, housing and protections.



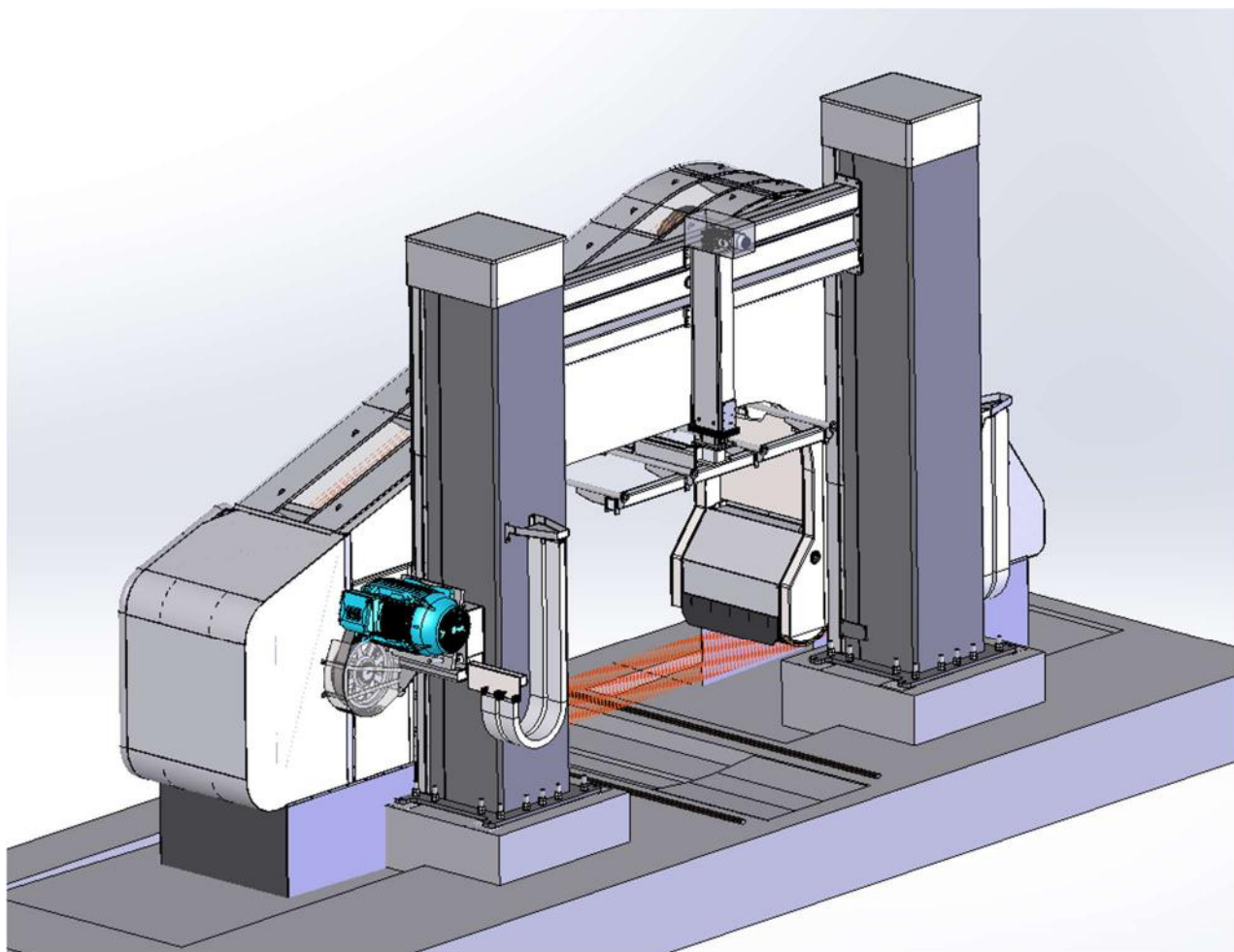

Fig. 6 - Detail of the main frame, columns and crossbar

## 5- FEATURES:

MODEL	NDF.6840/35
Number of WIRES	35 units
Machine height	7,65 mt
Machine length	11,40 mts
Block length	3500 mm.
Block height	2200 mm.
Thread length	23,50 mt
Diamond wire diameter	7,3 mm.
Vertical machine travel	2400 mm.
Steering wheel diameter	1800 mm.
Minimum thickness cuttable	21 mm.
Maximum separation between threads	979 mm (interior)
Diamond wire speed	0 – 35 mt/sc.
Main motor power	132 Kw
Total installed power	140 kW

## 6 - SAFETY

The NODOSAFER machines are protected gives a safety closure along its entire perimeter according to the CE safety standards.



## 7 – LOAD TROLLEY BLOCKS

